

NEW CONSTRUCTION KU-BAND ANTENNA WITH IMPROVED RADIATION DIAGRAM FOR SATELLITE BROADCASTING RECEIVING EARTH STATION

Peter Petkov¹, Elissaveta Alexandrova²

¹Technical University

²Bulgarian Astronautical Society

e-mail: e_alexandr@mail.bg

Abstract

The development of a new design small offset antenna with elliptical aperture equivalent to about 60 cm circular aperture intended for receiving earth stations in the band 11.7÷12.5 GHz of Broadcasting Satellite Service (BSS) is reported in the paper. The antenna mechanical and electrical characteristics are presented. The main antenna feature is the improved antenna radiation pattern in the plane of the geostationary satellite orbit (GSO) compared to the reference antenna pattern of BSS receiving earth stations in Annex 5 of Appendix 30 of the Radio Regulations (RR) that will contribute to less interference impact between real BSS systems in Ku-band especially systems with satellites located at comparatively closely situated GSO positions. The antenna parameters values achieved in this project are in support of the idea to improve the reference antenna pattern of the BSS earth stations that will contribute to more efficient use of the frequency spectrum-orbital resources in this band corresponding to the wording of Article 44 of the Constitution of the International Telecommunication Union (ITU) and the main principle of the RR for equitable access to frequency spectrum and GSO.

1. Introduction

The World Radiocommunication Conference 2000 (WRC-2000) adopted the international Plan for GSO BSS systems with national coverage based on a completely digital technology for television programs transmissions for Regions 1 and 3 countries (Europe, Africa, Asia and Australia). The down-link protection criteria in this BSS Plan are based on

the 60 cm reference antenna radiation pattern for the BSS receiving earth stations taken from ITU-R Recommendation BO.1213 with a half power beamwidth of almost 3° (2.86°) and included in Annex 5 of RR Appendix 30 (Fig.7bis) [1]. According to this reference radiation pattern at 3° orbital separation between BSS satellites positions on GSO discrimination of the co-channel co-polar Adjacent Satellite Interference (ASI) is about 13 dB and 18 dB for cross-polar applicable to BSS channels with circular polarization and 27 MHz BSS channel bandwidth. In the operational BSS systems the circular polarization has no popularity from the very beginning. By the time it is becoming more and more impossible circular polarization to be used, because of the numerous filings for additional use of the BSS band resources under the provisions of Article 4 of RR Appendix 30 intended to use BSS channels with linear polarization and especially with the preferred 33 MHz BSS channel bandwidth. The cross-polar discrimination for linear polarized signals according to the reference BSS receiving earth stations antenna pattern is decreasing up to 1 dB at around 3° off axis angles, because of the offset BSS channels arrangement and the use of 33 MHz BSS channel bandwidth. This circumstance makes completely impossible polarization reuse and reduces the opportunity to obtain coordination agreement for additional uses BSS systems and this creates difficulties for their implementation, as well as for the systems in the BSS Plan.

During the year 2012 „Bulgaria Sat” AD was awarded by the national regulatory authority CRC (Commission for regulation in communications) with permission to use GSO position 1.9°E for BSS system in case of successful coordination. At about 3° from both sides of this position the satellites of other countries BSS systems in operation are positioned. The analyses carried out showed that the three systems can operate at equal EIRP values without any perceptible mutual interference, however the existing coordination provisions [1] requires higher carrier-to-interference ratios than the actually needed. These provisions predetermined the WRC-12 decision on the Bulgarian proposal [2] the BSS channels in the lower part of the BSS band to be allowed for use from position 1.9° , however with quite low EIRP [3]. This Conference decision showed the need of a new antenna design for BSS receiving earth stations with improved electrical parameters: some higher maximum gain and improved radiation pattern particularly around 3° off-axis angle and better polarization discrimination.

2. Construction of the BSS receiving earth station antenna accordance

The proposed BSS receiving earth station antenna (elliptical offset) is designed in accordance with the recommendations in [4, 5]. The antenna reflector with aperture dimensions of 70 x 50 cm with elliptical rim (Fig.1) in a manner placing the feed out of the main beam of antenna pattern (Fig.2). The shift of the mechanical antenna axis from the electrical one (offset angle) is 30° . The antenna feed is a conical horn with an elliptical aperture complemented by choke (Fig.3) and dimensioned for achieving pattern symmetry and best possible maximum match with the feed waveguide in the full DTH TV band ($10.7 \div 12.75$ GHz) (Fig. 4).

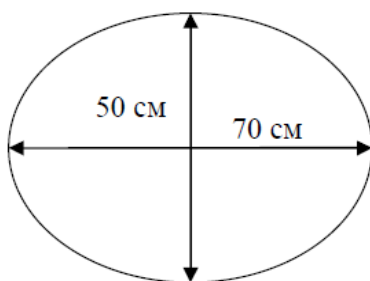

Fig. 1. Shape and size of antenna aperture

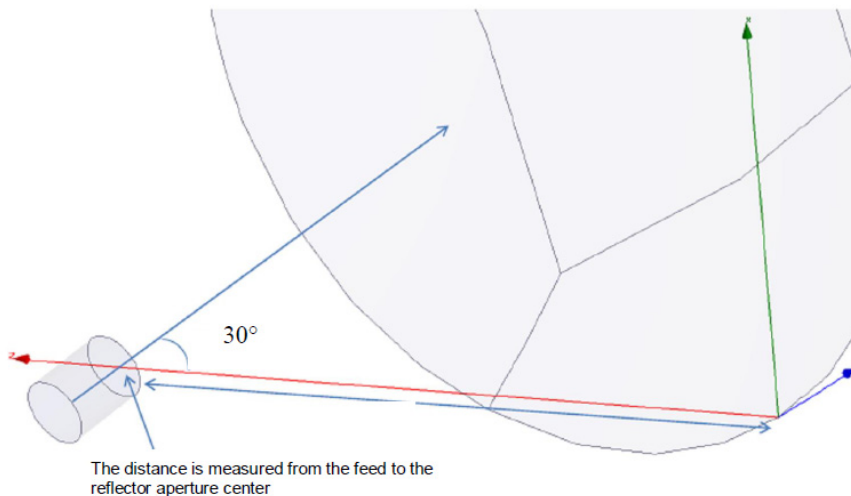

Fig. 2. Alignment the antenna feed

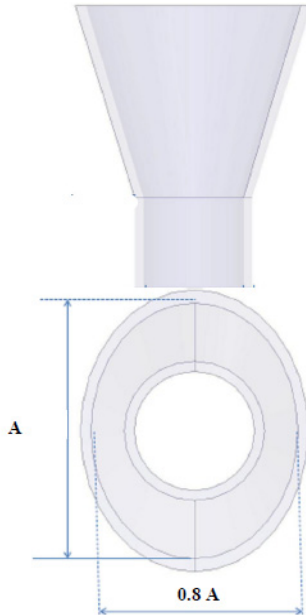

Fig. 3. Dimensioning of the antenna feed

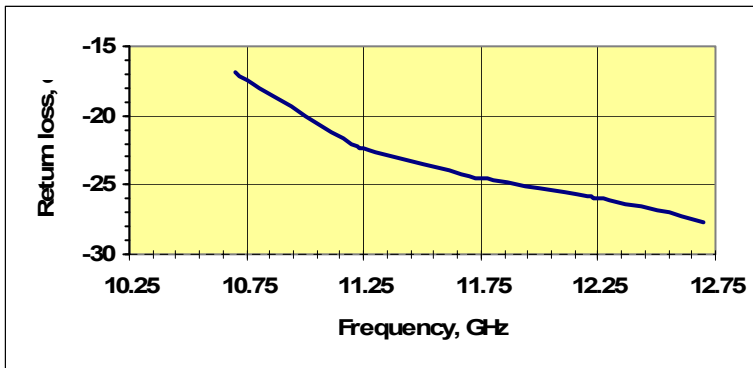

Fig. 4. Return loss of the antenna feed

3. Electrical characteristics of the new design BSS receiving earth station antenna

Theoretically determined maximum directivity of the new design BSS receiving earth station antenna at the BSS band middle frequency 12.2 GHz is over 36 dBi and the maximum cross-polar discrimination is over

30 dB in the cone of the co-polar component relative gain of -0.25 dB. Directivity values vs. frequency in the antenna operating band are summarized in Table 1.

The improvement of the new design BSS receiving earth station antenna radiation pattern in the GSO plane (horizontal plane) compared to the existing reference Regions 1 and 3 antenna radiation pattern for the receiving BSS earth stations in Annex 5 of RR Appendix 30 can be expressed by the following points (**Annex 1**):

1. Off-axis co-polar discrimination in the off-axis angle sector of 2.5° ÷ 3.5° is higher than 20 dB including 0.5 dB antenna mispointing error.
2. Cross-polarization discrimination is above 10 dB in the off-axis angle sector of 2.5° ÷ 3.5° including 0.5 dB antenna mispointing error.

It wasn't observed any perceivable variation of the main components of the new design BSS receiving earth station antenna radiation pattern in the off axis angles sector of $\pm 10^{\circ}$ throughout the whole BSS band and even throughout the whole antenna operating frequency band 10.7-12.5 GHz (**Annex 1**).

4. Tolerance analysis of the proposed new design BSS receiving earth stations antenna parameters

The expected decrease of the main beam antenna gain for the feed horn shift from the antenna focus along the three axis (Fig.5) is presented on Fig.6. It is evident that 1 cm shift of the antenna feed phase center from the focus of the parabolic reflector along each axis causes the maximum antenna gain decrease of less than 0.1 dB. The gain is most susceptible to a shift of the antenna feed phase center along the paraboloid axis; 0.5 dB decrease of the gain corresponds to 2 cm shift from the antenna focus. The antenna gain is substantially more tolerable to the feed twist around its own axes in the horizontal and vertical planes (Fig.7) than the cross-polarization discrimination; when the feed is twisted around the antenna vertical axis (elevation) with more than 3° the cross-polarization discrimination value falls below 20 dB, while the gain decreases with less than 0.04 dB.

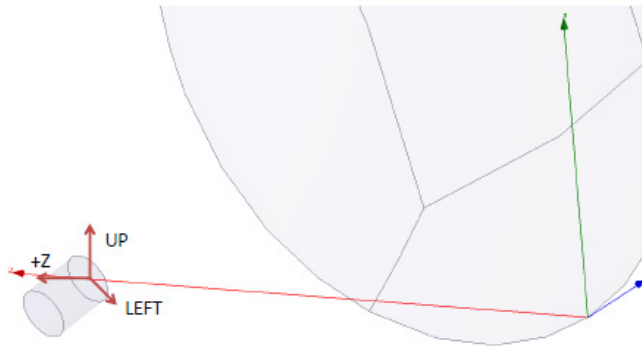

Fig. 5. Positioning of the antenna feed

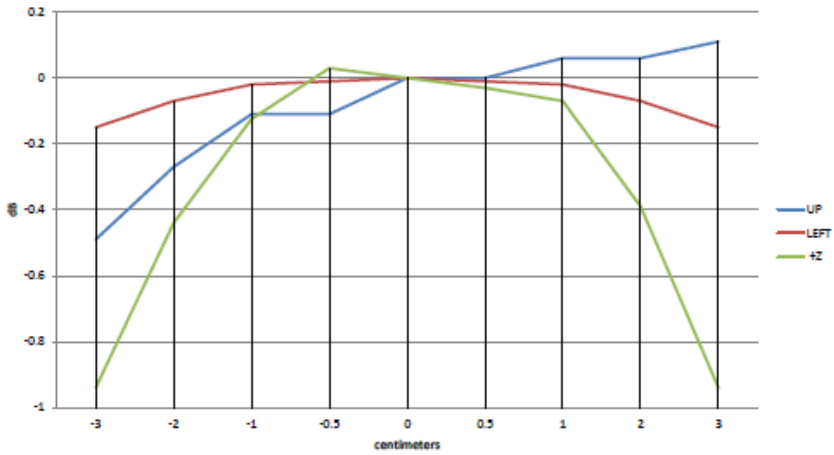

Fig. 6. Gain loss due to feed displacement (shift) from the parabolic reflector focus (Directions as per Fig. 5)

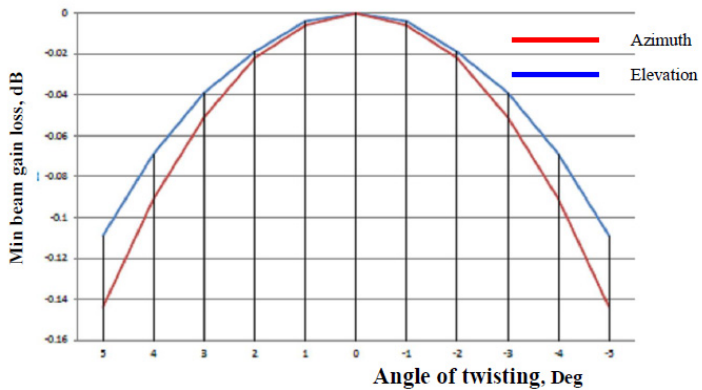

Fig. 7. Gain loss in case of feed twist around its axes

The impact of the root-mean-square (r.m.s.) deviation of the antenna reflector surface from the ideal paraboloid was analyzed at frequency 12.0 GHz which falls in the middle of the antenna operating frequency band and the results are presented here below:

r.m.s. deviation, mm	0	0.047	0.094	0.235	0.47	0.705	0.94	1.175	1.41
Gmax, dBi	36.2	36.199	36.194	36.154	36.011	35.773	35.44	34.99	34.45
Gmax decrease, dB	0	0.001	0.006	0.046	0.189	0.427	0.76	1.21	1.75

The deviation from the parabolic surface of the mass production small aperture antennas is typically less than 0.5 mm r.m.s. It results less than 0.2 dB decrease of the antenna gain theoretical value.

The values of the main beam antenna gain (Gmax) of the new design BSS receiving earth station antenna accounting for the losses due to the manufacturing allowances are summarized in Table 1. It can be seen that Gmax is apparently higher than 35.5 dBi at the mid BSS band frequency 12.2 GHz with aperture efficiency of 70 %.

Table 1.

Frequency, GHz	Polarization	Directivity, dBi	Feed shift loss, dB	Surface error loss, dB	Other losses, dB	Gmax, dBi
10.7	Vertical	34.98	0.2	0.19	0.25	34.34
10.7	Horizontal	34.87	0.2	0.19	0.25	34.23
11.725	Vertical	36.03	0.2	0.19	0.25	35.39
11.725	Horizontal	35.95	0.2	0.19	0.25	35.31
12.0	Vertical	36.25	0.2	0.19	0.25	35.61
12.0	Horizontal	36.15	0.2	0.19	0.25	35.51
12.75	Vertical	36.4	0.2	0.19	0.25	35.76
12.75	Horizontal	36.87	0.2	0.19	0.25	36.23

The losses due to finite conductivity of the reflector surface, antenna feed and waveguide are negligible, as well as the return loss (better than -18dB over the band of operation). They are summarized in the column “Other losses”, forming a significant safety margin of about 0.25 dB.

5. Preconditions for and expected results from the introduction of a new reference BSS receiving earth station antenna radiation pattern

The results from a comparative analysis were presented in [6] in which the potentially affected BSS systems and administrations by the Bulgarian BSS satellite system submitted at GSO position 1.9°E under the provisions of the Appendix 30 criteria for down-link direction based on the existing reference BSS receiving earth station antenna pattern were identified and compared with those obtained by applying the antenna pattern with steeper slopes like the presented above new design of BSS receiving earth station antenna. The analysis based on the narrower antenna pattern of the BSS receiving earth stations keeping all other conditions unchanged showed reduction of the number of the affected BSS systems and the number of administrations with which the coordination agreement have to be obtained was also reduced [6].

There are a number of BSS satellite systems submissions in ITU Region 1 at positions which fall in the BSS receiving earth stations antenna beam off-axis angle sector of 2.5°÷3.5° [6] of other BSS systems previously submitted to the ITU Radiocommunication Bureau (ITU-BR) and that's why having priority. The later submissions seem to be impossible to be brought into use, because of serious difficulties for notifying administrations to obtain coordination agreements due to usually quite great number of identified as affected ones. The reason for that is in a great extent the theoretically defined interference impact based on the use of the existing reference antenna pattern of BSS receiving earth stations. Observing the applicable protection ratios and the reference antenna pattern of the Regions 1 and 3 BSS receiving earth stations [1] even BSS systems at GSO positions separated with 6°÷7° are identified as affected. However, to obtain coordination agreement even in such cases is equally labor-consumption and expense-consumption and some times even impossible for non-technical reasons. Unnecessarily large number of systems and administrations with which agreements have to be sought is a barrier to successful coordination and recording of new BSS systems for additional uses of the BSS band in the Master International Frequency Register (MIFR) and impedes providing finances for their implementation. At the same time the ITU Region 2 BSS Plan (North and Sought America) is based on the reference antenna pattern of BSS receiving earth stations with comparatively narrower beam and antenna design independent. Such an approach leads to more effective use of the Region 2 BSS frequency-orbital resources than the corresponding for

the Regions 1 and 3. From the other side tightening of the reference antenna pattern defining in a great extent the access to and the effective use of GSO to the specific antenna dimension is not a perspective approach because the antenna technologies are continuously improving. The small Ku-band antenna manufacturing companies currently demonstrate achievement of much better antenna pattern discrimination in the vicinity of 3° off axis angle even for the same antenna size.

Making the reference antenna pattern of the Region 1 and 3 BSS receiving earth stations in Annex 5 to RR Appendix 30 (Fig.7bis) narrower especially in off axis angle region from 2.5° to 3.5° will ease the coordination procedure because the identification of the need for coordination is based on it and the number of the potentially affected BSS systems and administrations identified by the ITU-BR will be reduced. As a result much more BSS systems can be successfully coordinated and implemented at conditions of closely located positions of the BSS systems in the Plan and the submitted under RR Appendix 30 Article 4 [1].

6. Conclusion

The goals set forth the design of the new BSS receiving earth station antenna are achieved:

- the maximum gain is higher than 35.5 dBi @ mid frequency (BSS);
- the ASI suppression in a cone of 3° from the antenna main beam axis is over 15 dB throughout the BSS band;
- no perceptible change of the antenna radiation pattern throughout the BSS band is observed in the off-axis angle sector of ±10 degrees.

Having in mind the considerable margins demonstrated in the antenna gain analysis the presented new design antenna for BSS receiving earth stations will be suitable for mass production even with limited control over dimensions tolerances.

There is a trend of increasing of the number of the submitted to the ITU-BR RR Appendix 30 Annex 4 BSS systems and consequently decreasing of the orbital separation between the filed GSO positions that leads to less opportunity for successful coordination and as a result to ineffective use of the BSS frequency spectrum-orbital resources and the access of new satellite operators to them. This situation might be resolved based on the results of the new design BSS receiving earth station antenna demonstrating the feasibility to improve the reference antenna pattern of BSS Region 1 and 3 receiving earth stations and through its improvement to

facilitate the coordination procedure and the access to GSO for Region 1 and 3 countries.

Annex 1

Radiation patterns at both polarizations (V and H) in both orthogonal planes at 12 GHz and at both edge frequencies of the new BSS receiving antenna design frequency band

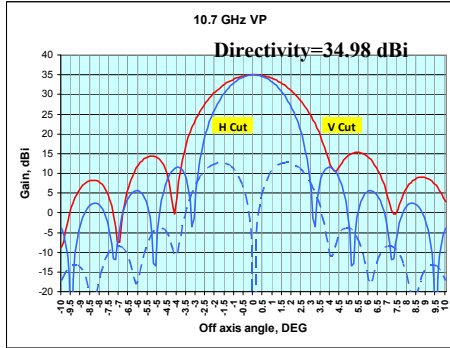

Off axis angle (θ), Deg

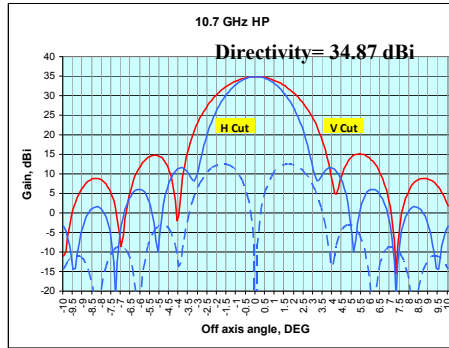

Off axis angle (θ), Deg

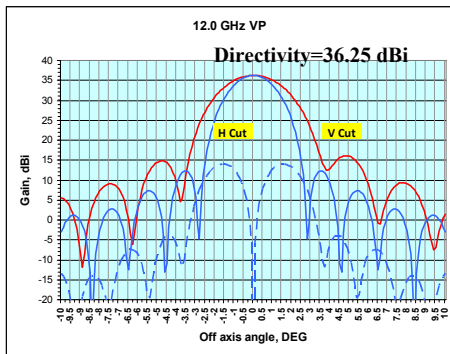

Off axis angle (θ), Deg

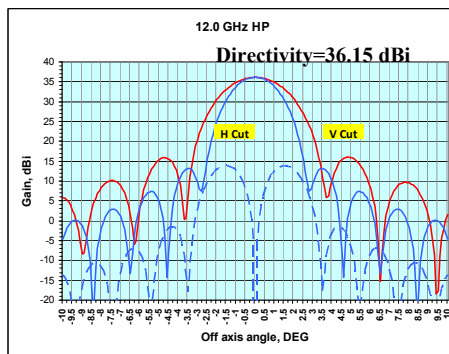

Off axis angle (θ), Deg

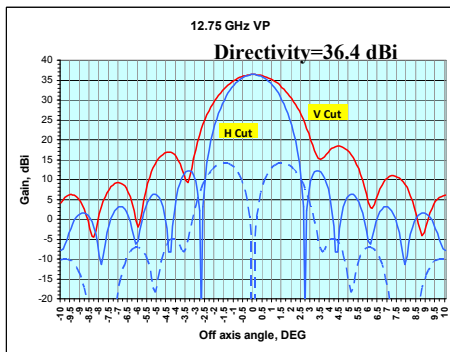

Off axis angle (θ), Deg

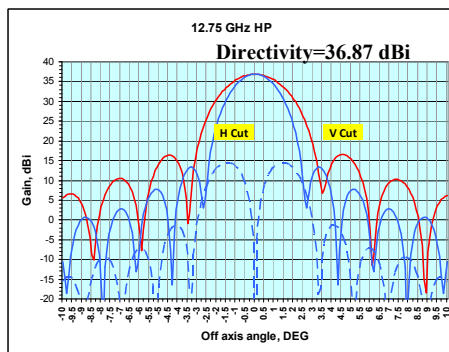

Off axis angle (θ), Deg

V Cut – in vertical plane (elevation), **H Cut** – in horizontal plane (azimuth)

References

1. Appendix 30 of the Radio Regulations, Edition of 2008.
2. Document 58 (Add.3), Bulgaria (Republic of), Proposal for the work of the Conference, World Radiocommunication Conference (Geneva, 23 January – 17 February 2012).
3. Document 517-E, 14 February 2012, Chairman of Committee 5, Six report from Committee 5 to the Plenary meeting, Agenda Item 7, World Radiocommunication Conference (Geneva, 23 January – 17 February 2012).
4. R u d g e, A. W., K. M i l n e, A. D. O l v e r and P. K n i g h t. The Handbook of Antenna Design, Peter Peregrinus Ltd, London, UK, 1982.
5. Antenna Handbook, Vol.2, Y.Lo & S.Lee, Eds., Van Nostrand Reinhold, New York, 1993.
6. Document 4A/43-E, 23 May 2012, Bulgaria (Republic of), Improvement of the RR Appendix 30 BSS receiving stations reference antenna pattern for Regions 1 and 3 as an opportunity for more efficient use of the spectrum/orbit resources for BSS systems and facilitation of the access to these resources by new comers, ITU-R Working Party 4A Meeting (Geneva, 30 May – 06 June 2012).

НОВА КОНСТРУКЦИЯ НА АНТЕНА ЗА ПРИЕМНА СТАНЦИЯ ЗА СПЪТНИКОВО ТЕЛЕВИЗИОННО РАЗПРЪСКВАНЕ В КУ-ОБХВАТА С ПОДОБРЕНА ДИАГРАМА НА ИЗЛЪЧВАНЕ

П. Петков, Е. Александрова

Резюме

В статията е представена разработката на нова конструкция на малка офсет антена с елиптична апертура, еквивалентна на кръгла апертура с диаметър около 60 см, предназначена за приемни земни станции в обхвата 11.7-12.5 GHz за спътниково телевизионно разпръскване (BSS). Представени са механичните и електрически характеристики на антената. Основното качество на антената е подобрената диаграма на излъчване в равнината на геостационарната спътникова орбита (GSO) в сравнение с еталонната диаграма на излъчване на антени за BSS приемни станции в Допълнение 5 на Приложение 30 на Международния радиорегламент (RR). По-добрата диаграма на излъчване ще допринесе за намаляване на влиянието на смущенията между спътници на сравнително близки GSO позиции. Стойностите на параметрите на антената, постигнати в този проект, са в подкрепа на идеята за подобряване на еталонната диаграма на антени за BSS приемни земни станции, което ще повиши ефективността при използване на честотно-орбиталните ресурси в този обхват, напълно в съответствие с призова в Член 44 на Конституцията на Международния съюз по далекосъобщения (ITU) и с основния принцип на RR за равноправен достъп до честотния спектър и геостационарната орбита.